

MADE  
IN  
AUSTRALIA

**Ledin**  
*BY DESIGN*

**EXPRESS DISPATCH**



[WWW.LEDINAUSTRALIA.COM.AU](http://WWW.LEDINAUSTRALIA.COM.AU)

**Ledin**  
*BY DESIGN*

MADE  
IN  
AUSTRALIA

MATILDA

WITH SOLID SURFACE BENCH TOP

The Matilda wall hung drawer and door unit provides the modern look with the functionality that we all need.

Two long drawers for everyday storage and a cupboard for larger items.

**Prime oak or Satin White Cabinet finish.**

Choice of Solid Surface Bench tops, choice of basins

Available in 900mm and 1200 mm.

Soft closing Door and Drawers.



# Ledin

BY DESIGN

MADE  
IN  
AUSTRALIA

## MATILDA

With STONE Bench top

The Matilda wall hung drawer and door unit provides the modern look with the functionality that we all need.

Two long drawers for everyday storage and a cupboard for larger items.

**Prime oak or Satin White Cabinet finish.**

Choice of Quartz stone Bench tops, White, Nougat, Armani, Pietra.

**Choice of on counter ceramic basins.**

Available in 900mm and 1200 mm.

Soft closing Door and Drawers.



Armani



Nougat



White



Pietra



**Ledin**  
*BY DESIGN*

MADE  
IN  
AUSTRALIA

## BANKSIA 600

With solid surface Bench top

The Banksia wall hung 2 door cabinet provides the essential storage space and at a depth of 410mm is perfect when space is at a premium.

**Prime oak or Satin White Cabinet finish.**

Choice of Solid Surface Bench tops, choice of basins

Available in 600mm wide x 410 deep x 500 high.

Soft closing Doors.



**Ledin**  
*BY DESIGN*

MADE  
IN  
AUSTRALIA

## WARATAH 700

With Solid surface Bench top

The Waratah 700mm wall hung 2 door cabinet provides the essential storage space.

**Prime oak or Satin White Cabinet finish.**

Choice of Solid Surface Bench tops, choice of basins

Available in 700mm wide x 460mm deep 500mm High

Soft closing Doors.





**Ledin**  
BY DESIGN

ON COUNTER  
CERAMIC BASINS

MADE  
IN  
AUSTRALIA



**PETITE ENSUITE**  
405 X 110 X 95



**PAIGE ENSUITE**  
425 x 310 X 125



**CHEZ**  
400 X 400 X 120



**CLASSIC**  
500 x 310 x 120



**HALO**  
360r X 130



**PYE**  
370r X 125



**SARINA**  
500x350x90



**KONA**  
500x380x120



**EGG**  
415x330x140

32mm Plug and waste required



**MINI ERIN-EDGE**  
310r X 110



**MINI ERIN**  
310r x100



**ANITA**  
400r x 110



**ERIN EDGE**  
370r X 120



**ERIN**  
370r X 120



**DARIA**  
500x340x110



**CRUZE -EDGE**  
460x325x140



**CRUZE**  
460x325x140



**AVA**  
320r x 105

32mm Plug and waste required

**Ledin**  
BY DESIGN

SEMI INSET

CERAMIC BASINS

MADE  
IN  
AUSTRALIA



**VANESSA SEMI INSET**  
450r X 50 out



**TATUM SEMI INSET**  
405r x 65 out



**VIOLA SEMI INSET**  
530x340 x 65 out



**BAILEY SEMI INSET**  
480 x 300 X 60 out



**CANDY SEMI INSET**  
450r x 65 out



32mm Plug and waste required



**Ledin**  
*BY DESIGN*

MADE  
IN  
AUSTRALIA

## KAKADU 600

With Moulded Solid surface top

The Kakadu wall hung 2 door cabinet provides the essential storage space and at a depth of 405mm is perfect when space is at a premium.

Prime oak or Satin White Cabinet finish.

Modern fully moulded satin white solid surface top that is reversible for left or right hand side basin. Available with no tap hole or one tap hole

Available in 600mm. Soft closing Doors.



**Ledin**  
*BY DESIGN*

MADE  
IN  
AUSTRALIA

## DAINTREE 700

With Moulded Solid surface top

**The Daintree 700mm wall hung 2 door cabinet provides the essential storage space.**

**Prime oak or Satin White Cabinet finish.**

**Modern fully moulded satin white solid surface top that is reversible for left or right hand side basin. Available with no tap hole or one tap hole**

**Available in 700mm. Soft closing Doors.**



**Ledin**  
*BY DESIGN*

MADE  
IN  
AUSTRALIA

## DAINTREE and KAKADU

Fully Moulded Solid surface tops

Modern fully moulded satin white solid surface tops that are reversible for left or right hand side basin. Available with no tap hole or one tap hole.



700 X 450 X 155

Daintree



600 X 405 X 155

kakadu

# BENCH TOP COLOURS

## SOLID SURFACE BENCH TOP COLOURS 12MM

Available on all cabinets



**CARRARA**



**GRECO**



**SLATE**



**ARCTIC WHITE**



**BELLA**

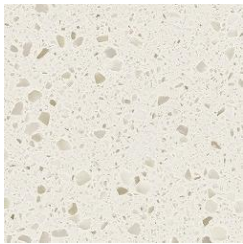

**PEBBLE**



**WHITE**



**CLOUD WHITE**



**HUSK**

## QUARTZ BENCH TOP COLOURS 20MM

Matilda range only



**Armani**



**Nougat**



**White**



**Pietra**

**Printing processes impose limitations on exact colour reproductions. Images are representative of colours only . Actual colour should be checked at your local stockist**



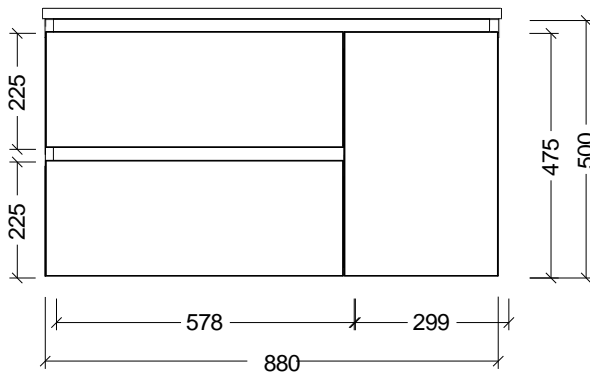

**CABINET:**  
880x450x500

**BENCHTOP:**  
900 x 460

**BASIN:**  
Add Height after  
selection

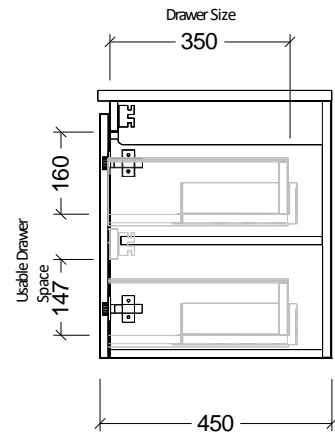
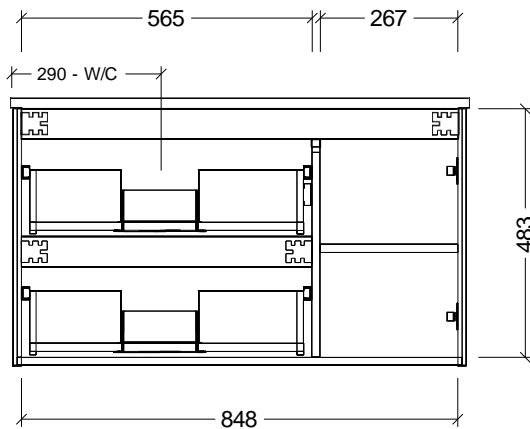

DIMENSIONS SHOWN ARE IN MILLIMETERS, ARE NOMINAL ONLY AND SUBJECT TO CHANGE AT ANY TIME. DO NOT SCALE DRAWINGS. INSTALLER TO CONFIRM ALL DIMENSIONS ON-SITE PRIOR TO INSTALL.

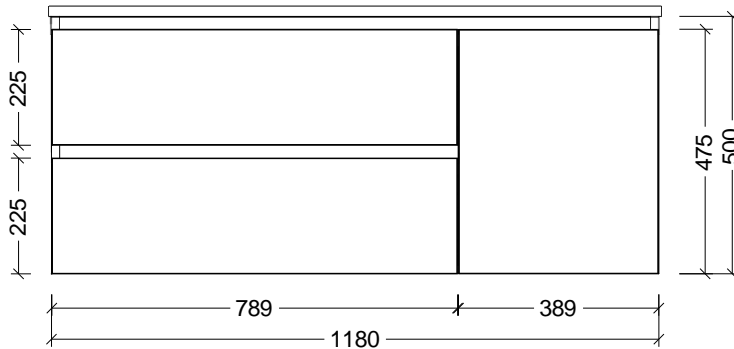

**CABINET:**  
1180x450x500

**BENCHTOP:**  
1200 x 460

**BASIN:**  
Add Height after  
selection

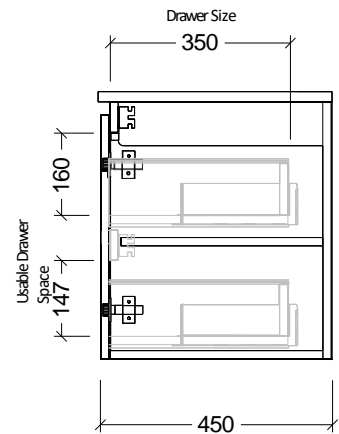
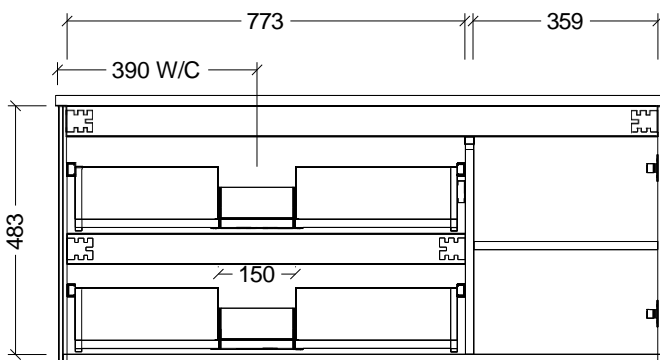

DIMENSIONS SHOWN ARE IN MILLIMETERS, ARE NOMINAL ONLY AND SUBJECT TO CHANGE AT ANY TIME. DO NOT SCALE DRAWINGS. INSTALLER TO CONFIRM ALL DIMENSIONS ON-SITE PRIOR TO INSTALL.

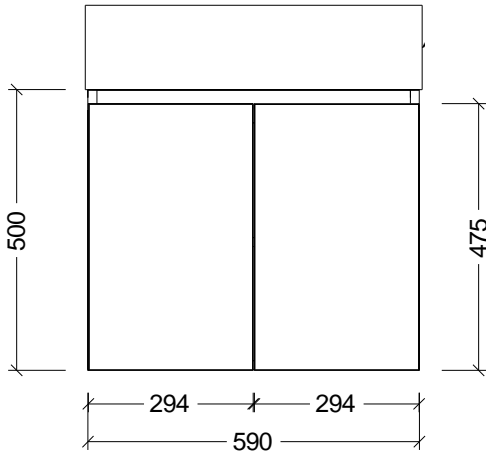

**CABINET:**  
590x403x500

**TOP:**  
600 x 405 X 155

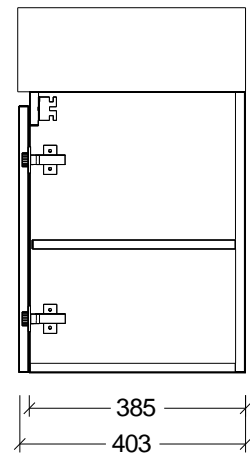
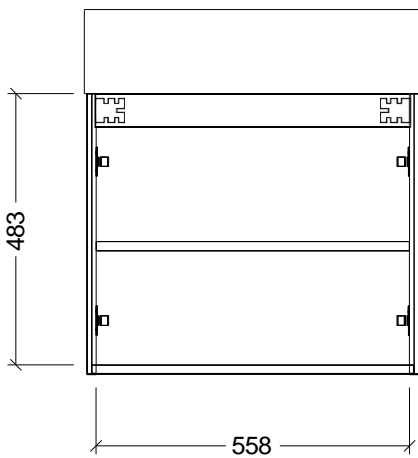

DIMENSIONS SHOWN ARE IN MILLIMETERS, ARE NOMINAL ONLY AND SUBJECT TO CHANGE AT ANY TIME. DO NOT SCALE DRAWINGS. INSTALLER TO CONFIRM ALL DIMENSIONS ON-SITE PRIOR TO INSTALL.

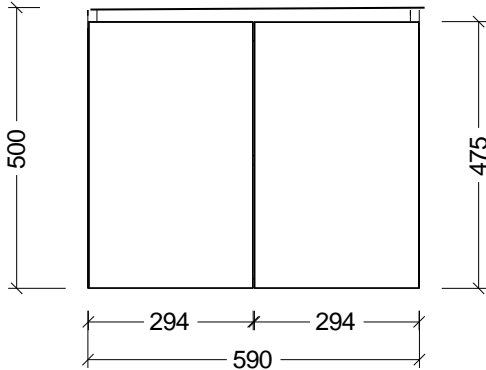

**CABINET:**  
590x403x500

**BENCH TOP:**  
600 x 410

**BASIN:**  
Add Height after  
selection

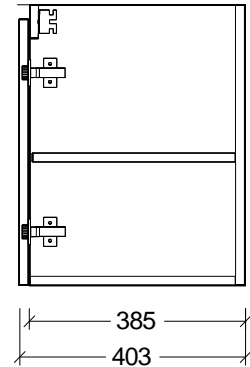
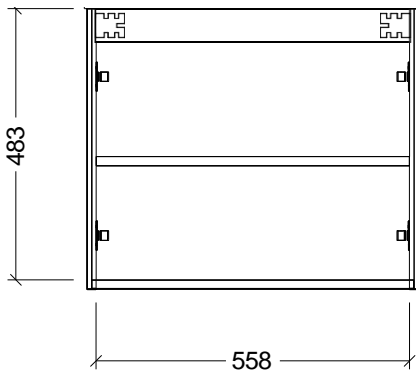

DIMENSIONS SHOWN ARE IN MILLIMETERS, ARE NOMINAL ONLY AND SUBJECT TO CHANGE AT ANY TIME. DO NOT SCALE DRAWINGS. INSTALLER TO CONFIRM ALL DIMENSIONS ON-SITE PRIOR TO INSTALL.



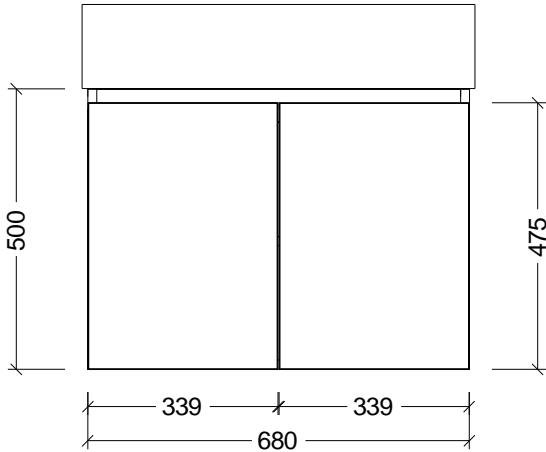

**CABINET:**  
680x448x500

**TOP:**  
700 x 450 X 155

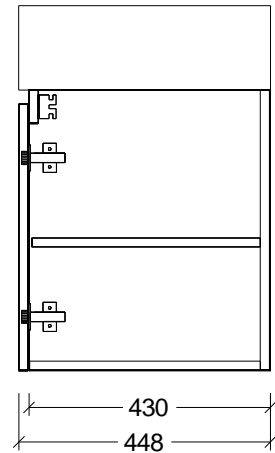
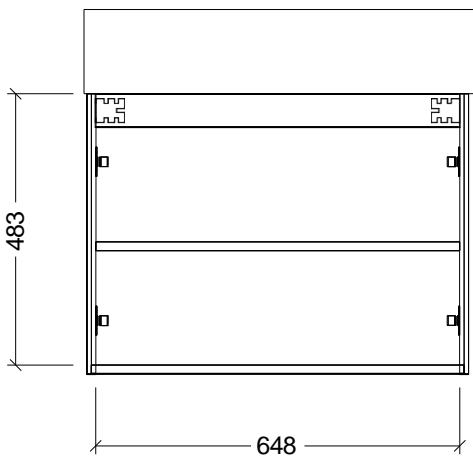

DIMENSIONS SHOWN ARE IN MILLIMETERS, ARE NOMINAL ONLY AND SUBJECT TO CHANGE AT ANY TIME.  
DO NOT SCALE DRAWINGS.  
INSTALLER TO CONFIRM ALL DIMENSIONS ON-SITE PRIOR TO INSTALL.

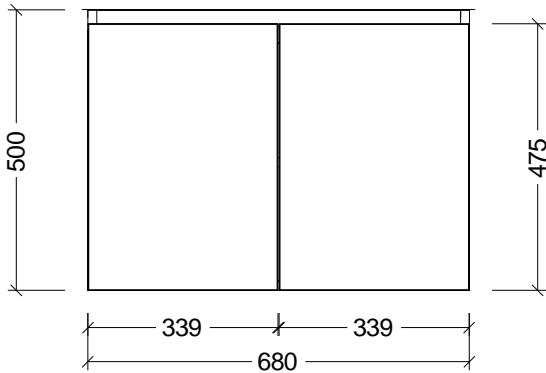

**CABINET:**  
680x448x500

**BENCH TOP:**  
700 x 460

**BASIN:**  
Add Height after  
selection

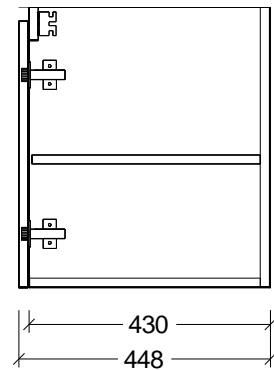
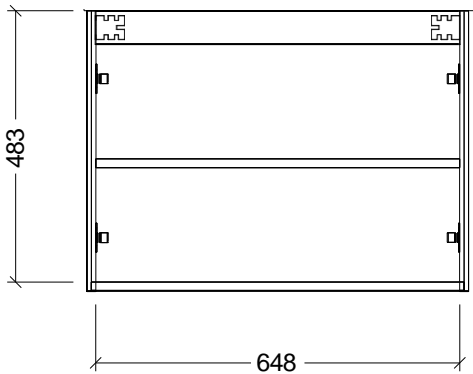

DIMENSIONS SHOWN ARE IN MILLIMETERS, ARE NOMINAL ONLY AND SUBJECT TO CHANGE AT ANY TIME. DO NOT SCALE DRAWINGS. INSTALLER TO CONFIRM ALL DIMENSIONS ON-SITE PRIOR TO INSTALL.



## WAREHOUSE AND CONTACT DETAILS

*Unit 11, 274 -276 Hoxton Park Rd Prestons NSW*

*All mail to P.O Box 364 Padstow NSW 2211*

*Fax: 02 858 289 81*

*Email: [sales@ledinaustralia.com.au](mailto:sales@ledinaustralia.com.au)*

*Website: [www.ledinaustralia.com.au](http://www.ledinaustralia.com.au)*

## WARRANTY INFORMATION

LEDIN AUSTRALIA PTY LTD WARRANTS THE PRODUCTS WE DISTRIBUTE FOR THE PERIOD OF FIVE YEARS FROM THE DATE OF PURCHASE. LEDIN AUSTRALIA PTY LTD WILL AT ITS DISCRETION, PURSUANT TO ITS OBLIGATIONS UNDER THE COMPETITION AND CONSUMERS ACT 2010: REPAIR OR REPLACE THE DEFECTIVE PRODUCT OR PARTS.

**ALL ITEMS MUST BE INSPECTED THOROUGHLY BEFORE INSTALLATION. FOR FAULTS OR DAMAGE. IF A FAULT IS FOUND IMMEDIATELY NOTIFY LEDIN AUSTRALIA OR YOUR PLACE OF PURCHASE. THE ITEM MUST NOT BE INSTALLED WITHOUT AUTHORITY FROM LEDIN AUSTRALIA PTY LTD. NO CLAIMS WILL BE ACCEPTED WITHOUT THIS AUTHORITY**

THIS WARRANTY DOES NOT COVER DAMAGE BY IMPROPER INSTALLATION, NEGLIGENCE OR MISUSE, IMPROPER CARE AND MAINTENANCE, WATER DAMAGE AND NATURAL CAUSES SUCH AS SUNLIGHT OR EXCESSIVE HUMIDITY. IT SHOULD BE NOTED THAT ALL CABINETS ARE MANUFACTURED FROM WATER RESISTANT MATERIALS BUT ARE **NOT WATERPROOF**. ALL CARE MUST BE TAKEN IMMEDIATELY TO DRY ANY SPILLAGE OF WATER THAT MAY GAIN ENTRY TO THE CABINET. ALL CLAIMS FOR WARRANTY SHOULD BE REPORTED TO THE ORIGINAL PLACE OF PURCHASE WITH A COPY OF PURCHASE RECEIPT. CABINETS MUST NOT BE AFFIXED IN BY TILES, AND CABINETS MUST BE INSTALLED IN SUCH A WAY THAT THEY CAN BE REMOVED IF REQUIRED WITHOUT DISTURBING ANY TILES. CABINETS MUST BE PROTECTED FROM WATER FROM BATHS AND SHOWERS BY PROTECTIVE SCREENS. **CABINETS MUST BE SCREWED TO THE WALL**

REGULATION 90 OF THE ACL 2010 STATES: *OUR GOODS COME WITH GUARANTEES THAT THAT CANNOT BE EXCLUDED UNDER THE AUSTRALIAN CONSUMER LAW. YOU ARE ENTITLED TO A REPLACEMENT OR REFUND FOR A MAJOR FAILURE AND FOR COMPENSATION FOR ANY OTHER REASONABLY FORESEEABLE LOSS OR DAMAGE. YOU ARE ALSO ENTITLED TO HAVE THE GOODS REPAIRED OR REPLACED IF THE GOODS FAIL TO BE OF ACCEPTABLE QUALITY AND THE FAILURE DOES NOT AMOUNT TO A MAJOR FAILURE.*

---